

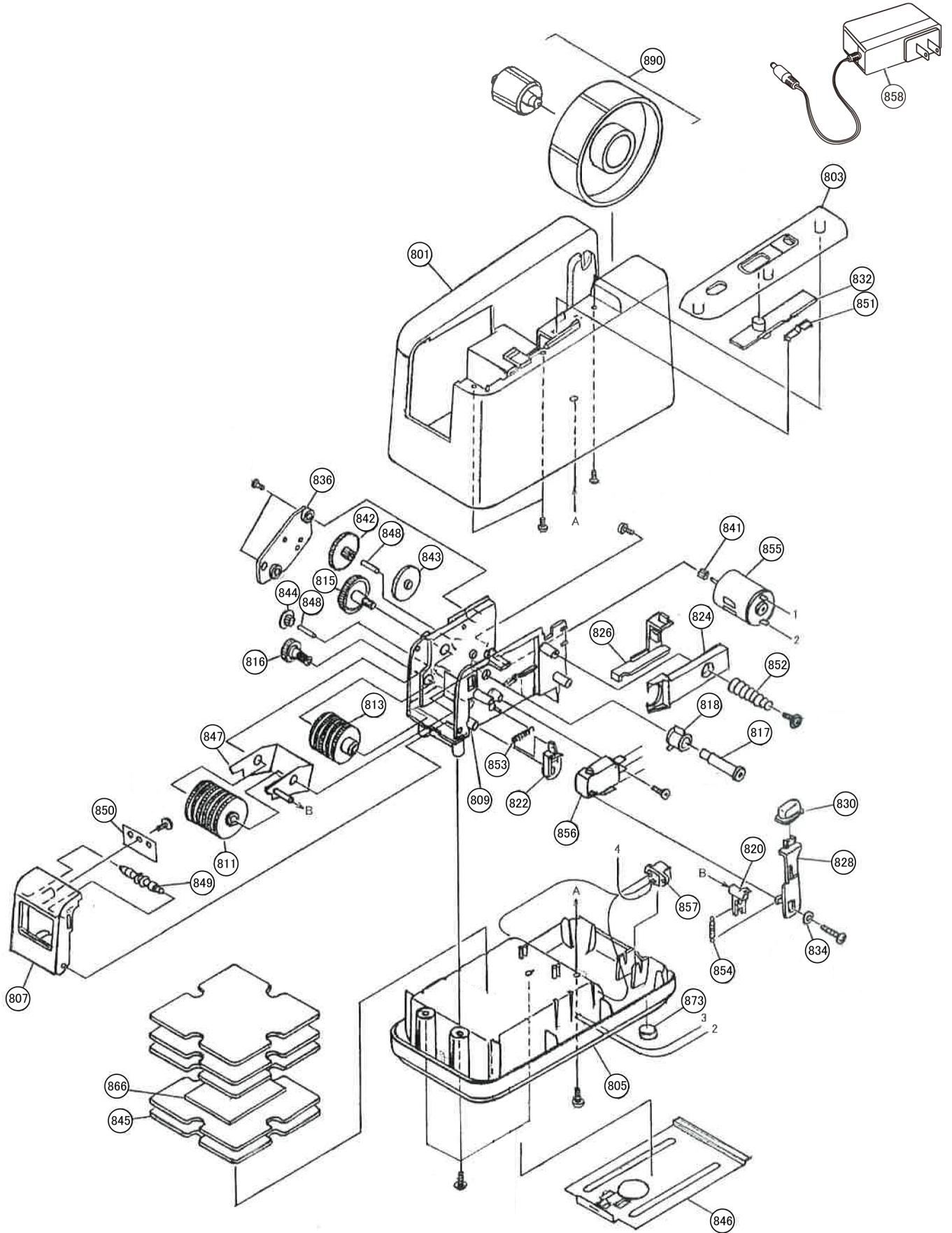

















部品展開図

M-800 ECT®

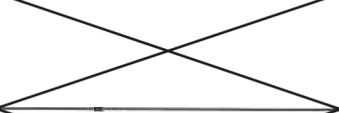
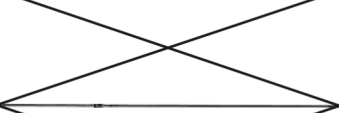
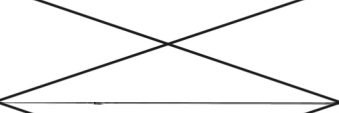
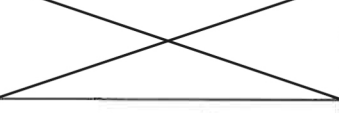

M-800部品表

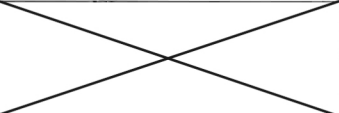
品番	部品名称	略図	品番	部品名称	略図
801	カバー		830	フリーボタン	
803	カバープレート		832	切り替えボタン	
805	ベース(接点付)		834	カラー	
807	カッターホルダー		836	ギアカバー	
809	フレーム		841	ピニオン(10)	
811	主ローラー		842	平ギア1	
813	副ローラー		843	平ギア2	
815	主ギア		844	平ギア24	
816	副ギア		845	重り板	
817	主ローラーシャフト		846	電池カバーユニット	
818	クラッチ板		847	押さえローラー 受けユニット	
820	スイッチレバー		848	ギアシャフト	
822	ホールドレバー		849	押さえローラー	
824	クラッチレバー		850	カッター刃	
826	切り替えレバー		851	スライドバネ	
828	フリーレバー		852	圧縮スプリング	

品番	部品名称	略図
853	スイッチスプリング	
854	ホールドスプリング	
855	モーター	
856	マイクロスイッチ V-10	
857	ジャック	
858	アダプター	
860	リード線A 75mm(ジャック)	
861	リード線B 90mm(マイクロ)	
862	リード線C 120mm(マイクロ)	
863	リード線D 150mm(ジャック)	
864	リード線E 175mm(モーター)	
865	リード線F 190mm(モーター)	
866	マット	
869	化粧箱	
873	底ゴム	
880	注意ラベル	
890	リールユニット	